



DIVISION: 06 00 00—WOOD, PLASTICS AND COMPOSITES
Section: 06 05 23—Wood, Plastic and Composite Fastenings

REPORT HOLDER:

SCHRAUBENWERK GAISBACH GmbH (SWG)

EVALUATION SUBJECT:

SWG ASSYPLUS VG AND VG 4 WOOD-DRILLING SCREWS

1.0 EVALUATION SCOPE

Compliance with the following codes:

- 2018, 2015, 2012 and 2009 *International Building Code*® (IBC)
- 2018, 2015, 2012 and 2009 *International Residential Code*® (IRC)

Property evaluated:

Structural

2.0 USES

SWG ASSYplus VG and VG 4 Wood-drilling Screws are alternate dowel-type threaded fasteners used in engineered wood-to-wood and steel-to-wood connections designed in accordance with the IBC. For structures regulated under the IRC, the screws may be used when an engineered design is submitted in accordance with IRC Section R301.1.3.

3.0 DESCRIPTION

3.1 General:

SWG ASSYplus VG and VG 4 screws are self-drilling, self-tapping screws which have a drill point and one of three head styles (cylindrical, countersunk, or countersunk with milling pockets), as shown in Figures 1 through 3. The VG screw heads have a recess for use with an AW drive, and the VG 4 screw heads have a recess for use with an RW drive, which are proprietary driving bits available from the report holder. The screws are available with nominal diameters of 1/4, 5/16, 3/8 and 1/2 inch (6, 8, 10 and 12 mm). The screws are fully threaded and are available in varying lengths as shown in Tables 1A and 1B. The specified diameters and other dimensions are provided in Table 1A and 1B for each screw. The screws are available in boxes of loose fasteners.

3.2 Materials:

3.2.1 SWG ASSYplus VG and VG 4 Screws: The screws are manufactured from carbon steel wire complying with the manufacturer's specifications. After the heads are formed and the threads are rolled, the screws are hardened, in accordance with the manufacturer's specifications. The hardened screws are then galvanized with a minimum zinc coating thickness of 5 µm and coated with a lubricant.

3.2.2 Wood Members: Wood members may be sawn lumber; structural glued laminated timber (glulam) or parallel strand lumber (PSL) which is a type of structural composite lumber (SCL). Screws may also be used in the face of cross-laminated timber (CLT) panels.

For purposes of connection design, sawn lumber members must have an assigned specific gravity as indicated in the tables in this report. Assigned specific gravity for sawn lumber must be determined in accordance with Table 12.3.3A of the ANSI/AWC National Design Specification for Wood Construction® (NDS) (Table 11.3.3A of the NDS for the 2012 IBC, Table 11.3.2 of the NDS for the 2009 IBC). Sawn wood side and main members must have a moisture content less than or equal to 19 percent at the time of screw installation and while in service.

For the purposes of connection design, glulam members must have a Specific Gravity for Fastener Design (addressed in Tables 5A through 5D of the NDS Supplement), as indicated in the tables in this report. Glulam members must have a moisture content of less than 16 percent at the time of screw installation and while in service.

When designing connections with screws installed into the face of CLT panels, all of the laminations must have a minimum assigned specific gravity in accordance with the NDS as indicated in the tables in this report. Moisture content must be less than 16 percent.

For PSL, the moisture content at the time of installation and in service must be in accordance with the applicable ICC-ES evaluation report on the PSL. Parallel strand lumber (PSL) must have a minimum equivalent specific gravity, given in the applicable ICC-ES evaluation report, of 0.50.

Use of the screws in engineered wood products (EWP) other than those addressed above is outside the scope of this report.

The thickness of the wood main member, t_m , must be sufficient to ensure that the tip of the screw is embedded in the wood, with a minimum thickness of wood beyond the tip (cover) of 3/8 inch (9.5 mm). Unless noted otherwise, the

minimum thickness of both main and side members must also be as follows: $^{15}/_{16}$ inch (24 mm) for $^{1}/_{4}$ -inch-diameter (6 mm) screws; $^{3}/_{16}$ inches (30 mm) for $^{5}/_{16}$ -inch-diameter (8 mm) screws; $^{9}/_{16}$ inches (40 mm) for $^{3}/_{8}$ -inch-diameter (10 mm) screws; and $^{33}/_{16}$ inches (80 mm) for $^{1}/_{2}$ -inch-diameter (12 mm) screws.

3.2.3 Steel Side Plates: Steel side plates must comply with the minimum requirements of ASTM A36. Steel plate thickness must be as required by Section 4.1.4. For use with screws installed at an incline, slotted holes must be predrilled to accommodate wedge washers.

3.2.4 Wedge Washers: Steel wedge washers are provided by the screw manufacturer for use with screws installed at an incline through steel side plates into wood members. See Figure 6.

4.0 DESIGN AND INSTALLATION

4.1 Design:

4.1.1 General: The design values in this report are intended to aid the designer in meeting the requirements of IBC Section 1604.2. For connections not completely described in this report, determination of the suitability of the ASSYplus VG and VG 4 screws for the specific application is the responsibility of the designer and is outside the scope of this report. The designer is responsible for determining the available strengths for the connection, considering all applicable limit states, and for considering serviceability issues.

For design information for ASSYplus VG and VG 4 screws used in wood-to-wood connections where the screws are installed perpendicular to the grain of the wood main member, see Section 4.1.3.

For design information for groups of ASSYplus VG and VG 4 screws used in wood-to-wood and steel-to-wood connections used to transfer lateral load, where the screws are installed at a 45 degree angle to the grain of the wood member(s), see Section 4.1.4.

4.1.2 Screw Strength: Allowable screw shear and tension strengths (ASD) and design screw shear and tension strengths (LRFD) and minimum specified bending yield strength for the screws are shown in Tables 1A and 1B, as applicable.

4.1.3 Connections with Screws Installed Perpendicular to the Grain of the Main Member:

4.1.3.1 Governing Design Values: The allowable lateral load for a single-screw connection is the lesser of: (a) the reference lateral design value described in Section 4.1.3.2, adjusted by all applicable adjustment factors, and (b) the allowable screw shear strength given in Table 1A or 1B, as applicable. The allowable load for a single-screw connection in which the screw is subject to tension is the least of: (a) the reference withdrawal design value described in Section 4.1.3.3, multiplied by the effective thread penetration in the main member, $p_{t,m}$, (length in the main member minus the tip length) and adjusted by all applicable adjustment factors; (b) the greater of the following, adjusted by all applicable adjustment factors: the reference withdrawal design value described in Section 4.1.3.3, multiplied by the effective thread penetration in the side member, $p_{t,s}$, (length in the side member minus the unthreaded length) and the reference head pull-through design value described in Section 4.1.3.3; and (c) the allowable screw tension strength given in Table 1A or 1B, as applicable.

4.1.3.2 Reference Lateral Design Values (Z): Reference lateral design values for select wood-to-wood connection

configurations are given in Table 2 based on calculations in accordance with the NDS. For other connection configurations, reference lateral design values for single shear connections with the screws loaded parallel or perpendicular to grain may be determined in accordance with Section 12.3.1 of the NDS (Section 11.3.1 of the NDS for the 2012 and 2009 IBC) using the following parameters and limitations:

1. The applicable specified bending yield strength from Table 1A or 1B must be used for design.
2. The wood side member thickness must be a minimum of $1^{3}/_{4}$ inches (45 mm).
3. The minimum effective screw penetration into the main member, excluding tip length, must be $6D$, where D is the nominal diameter of the screw.
4. The minor thread diameter, D_r , must be used to determine R_d and K_D in accordance with Table 12.3.1B of the NDS, the dowel bearing strength in accordance with Table 12.3.3 of the NDS and the reference lateral design value based on Table 12.3.1A of the NDS (Tables 11.3.1B, 11.3.3 and 11.3.1 A of the NDS for the 2015 IBC; Tables 11.3.1B, 11.3.2 and 11.3.1A of the NDS for the 2009 IBC).
5. For sawn lumber and installation into the face of CLT panels, the specific gravity used for design purposes must be the assigned specific gravity in accordance with Table 12.3.3A of the NDS (Table 11.3.3A of the NDS for the 2012 IBC, Table 11.3.2A of the NDS for the 2009 IBC).
6. For glulam, the specific gravity used for design purposes must be the applicable Specific Gravity for Fastener Design, given in Section 5 of the NDS Supplement.
7. For PSL, the specific gravity used for design purposes must be the equivalent specific gravity for the PSL given in the applicable ICC-ES evaluation report.
8. Spacing, edge and end distance must be in accordance with Table 5 to prevent splitting of the wood.

4.1.3.3 Reference Withdrawal Design Values (W) and Head Pull-through Design Values (W_H): Reference withdrawal design values and reference head pull-through design values for SWG ASSYplus VG and VG 4 screws are given in Tables 3 and 4, respectively. The minimum effective screw penetration into the main member, p_t , excluding tip length, must be $8D$.

4.1.3.4 Adjustments to Reference Design Values: Reference design values must be adjusted in accordance with the requirements for dowel-type fasteners in Section 11.3 of the NDS (Section 10.3 of the NDS for the 2012 and 2009 IBC) to determine allowable loads for use with ASD and design loads for use with LRFD. Use is limited to dry in-service conditions, such that the wet service factor, C_M , is 1.0 in accordance with the NDS. The reference design values must also be adjusted in accordance with the requirements in Section 12.5 of the NDS (Section 11.5 of the NDS for the 2012 and 2009 IBC). When the capacity of a connection is controlled by the fastener strength, the allowable connection strength must not be increased by the adjustment factors specified in the NDS.

4.1.3.5 Connections with Multiple Screws: Connections containing multiple SWG ASSYplus VG and VG 4 screws must be designed in accordance with Sections 11.2.2 and

12.6 of the NDS (Sections 10.2.2 and 11.6 of the NDS for the 2012 and 2009 IBC).

4.1.3.6 Combined Loading: Where SWG ASSYplus VG and VG 4 screws are subjected to combined lateral and withdrawal loads, connections must be designed in accordance with Section 12.4.1 of the NDS (Section 11.4.1 of the NDS for the 2012 and 2009 IBC).

4.1.3.7 Capacity Requirements for Wood Members: When designing a connection, the structural members must be checked for load-carrying capacity in accordance with Section 11.1.2 of the NDS (Section 10.1.2 of the NDS for the 2012 and 2009 IBC), and local stresses within multiple-fastener connections must be checked against Appendix E of the NDS to ensure the capacity of the connection and fastener group.

4.1.3.8 Design of Metal Parts: Design of connections using steel side plates must comply with Section 11.2.3 of the NDS (Section 10.2.3 of the NDS for the 2012 and 2009 IBC).

4.1.4 Connections Made with Multiple Inclined Screws:

4.1.4.1 General: Connections used to transfer lateral loads between side members and a main member using groups of SWG ASSYplus VG and VG 4 screws installed at a 45-degree angle to the grain of the wood members must be designed in accordance with this section. Specific design procedures for steel-to-wood connections are addressed in Section 4.1.4.3. Specific design procedures for wood-to-wood connections are addressed in Section 4.1.4.4. The expected slip between the side member(s) and the main member at design load is less than 1/16 inch (1.6 mm).

4.1.4.2 Applicable Parameters: The design methods presented in Section 4.1.4 apply under the following conditions:

1. The connections are two or three member connections with a wood main member and either wood or steel side member(s).
2. Assigned specific gravity for sawn lumber and glulam, and equivalent specific gravity for PSL, must be within the ranges shown in Tables 3 and 4.
3. Screws used with steel side plates and wedge washers must be ASSYplus VG or VG 4 screws with countersunk heads.
4. The screws must be installed at a 45-degree angle to the wood grain, which is parallel to the direction of the force being transferred between the members.
5. The effective screw penetration in both the wood main member, $p_{t,m}$, and the wood side member, $p_{t,s}$, must be a minimum of 8D, measured along the axis of the screw.
6. A minimum of 2 screws must be used in each connection.
7. Spacing, edge distance and end distance must be as described in Table 5 and Figures 4, 5 or 7, as applicable.
8. Wood side members must be of sufficient thickness to accommodate a minimum thread length of 8D plus the length of the unthreaded portion of the screw, 'a', shown in Table 1.
9. For connections of steel side plates to wood main members, the spacing between the outermost

screws perpendicular to grain must not exceed 5 inches (127 mm).

10. Steel side plate thickness must be as shown in the following table, to accommodate the available wedge washers:

NOMINAL SCREW DIAMETER (inch)	MIN. PLATE THICKNESS (inch)	MAX. PLATE THICKNESS (inch)
5/16	3/16	1/2
3/8	1/4	3/4
1/2	1/4	1

For SI: 1 inch = 25.4 mm

4.1.4.3 Steel-to-Wood Connections:

4.1.4.3.1 Two-member Connections: The allowable lateral load for a two-member connection with a steel side member and a wood main member must be determined as follows:

1. Determine the length of the screw in the side member as follows:

$$l_s = l_w + t_s / \cos 45^\circ$$

Where:

l_w = the length of the screw in the wedge washer. (See Figure 6)

t_s = the thickness of the steel side member.

2. Determine the effective length of the screw in the main member as follows:

$$p_{t,m} = L - l_s - L_t$$

Where:

L = the length of the screw as shown in Table 1 and Figures 1 through 3.

L_t = the tip length of the screw as shown in Table 1 and Figures 1 through 3.

3. Determine the applicable reference withdrawal design value for the screw installed at 45° to the grain of the wood, in pounds-force per inch, W_{45} , by referring to Table 3. Then determine the allowable withdrawal strength in the main member, W'_m , as follows:

$$W'_m = W_{45} \cdot p_{t,m} \cdot C'$$

Where:

C' = the product of all applicable adjustment factors determined in accordance with the NDS. C_g does not apply.

4. If the allowable withdrawal strength in the main member is less than the allowable fastener tension strength, T_a , shown in Table 1, the allowable lateral strength of the multiple fastener connection, P_a , must be determined as follows:

$$P_a = 0.9 \cdot n \cdot W'_m \cdot \cos 45^\circ$$

Where:

n = the number of screws acting together in the shear plane.

5. If the allowable withdrawal strength in the main member exceeds the allowable fastener tension strength, T_a , shown in Table 1, the allowable lateral strength of the multiple fastener connection must be determined as follows:

$$P_a = 0.9 \cdot n \cdot T_a \cdot \cos 45^\circ$$

6. The structural members must be checked for load-carrying capacity along the entire load path in accordance with the code. This verification must include, but not be limited to, verifying the longitudinal shear capacity of the wood member; the cross tension capacity of the wood member; and the fastener group or individual fastener wood tear out capacities.

4.1.4.3.2 Three-member Connections: The allowable lateral load for a three-member connection with two steel side members and a wood main member is equal to two times the allowable lateral load for a two-member connection with a steel side member and a wood main member, determined in accordance with Section 4.1.4.3.1.

4.1.4.4 Wood-to-wood Connections:

4.1.4.4.1 Two-member Connections: The allowable lateral load for a two-member connection with a wood side member and a wood main member must be determined as follows:

1. Determine the effective length of the screw in the side member as follows:

$$p_{t,s} = (t_s / \cos 45^\circ) - a - l_H$$

Where:

t_s = The thickness of the wood side member.

a = The dimension from the top of the screw head to the start of the threads, as shown in Table 1 and Figures 1 through 3.

l_H = for screws countersunk beneath the surface of the wood, the dimension from the surface of the wood to the top of the countersunk head, measured along the axis of screw.

2. Determine the effective length of the screw in the main member as follows:

$$p_{t,m} = L - (p_{t,s} + a) - L_t$$

3. Determine the applicable reference withdrawal design value for the screw installed at 45° to the grain of the wood, in pounds-force per inch, W_{45} , by referring to Table 3.

4. Determine the allowable withdrawal strength in the side member and the main member, as follows:

$$W'_s = W_{45} \cdot p_{t,s} \cdot C'$$

$$W'_m = W_{45} \cdot p_{t,m} \cdot C'$$

5. If the allowable withdrawal strength in either the side member or the main member (or both) is less than the allowable fastener tension strength shown in Table 1, the allowable lateral strength of the multiple fastener connection must be determined as follows:

$$P_a = 0.9 \cdot n \cdot \min \left[\frac{W'_s}{W'_m} \right] \cdot \cos 45^\circ$$

6. If both the allowable withdrawal strength in the side member and the allowable withdrawal strength in the main member exceed the allowable fastener tension strength shown, T_a , in Table 1, the allowable lateral strength of the connection must be determined as follows:

$$P_a = 0.9 \cdot n \cdot T_a \cdot \cos 45^\circ$$

7. The structural members must be checked for load-carrying capacity in accordance with Section 4.1.4.3.1.

4.1.4.4.2 Three-member Connections: The allowable lateral load for a three-member connection with two wood

side members and a wood main member is equal to two times the allowable lateral load for a two-member connection with a wood side member and a wood main member, determined in accordance with Section 4.1.4.4.1.

4.2 Installation:

4.2.1 General: SWG ASSYplus VG and VG 4 screws must be installed in accordance with the manufacturer's published installation instructions, the approved plans and this report.

Screws must be driven using the manufacturer-recommended drive bit, with a rotary drill, or a percussion drill set to rotary only mode. After installation, the flat surface of the countersunk heads and the top of the cylindrical heads must be flush with the surface of the side member, for screws installed perpendicular to wood side members. For screws installed at an incline, the head of the screw relative to the surface of the wood or steel side member must be as shown in Figures 4, 5 and 7, as applicable. The screws must not be overdriven and the side member(s) must be in direct contact with the main member, such that no gap exists between the members.

4.2.2 End Distance, Edge Distance and Spacing:

Minimum wood member end distances, edge distances and spacing of the screws must be sufficient to prevent splitting of the wood, or as required by Table 5, whichever is greater. When the screws are used in PSL, the minimum screw end and edge distances and spacing must be in accordance with Table 5 or in accordance with the ICC-ES evaluation report on the PSL, whichever is more restrictive. Steel plate edge and end distance must be a minimum of 1.5 times the diameter of the screw and spacing between screws in a row and between rows of screws must be a minimum of 3 times the diameter of the screw. For slotted holes, the minimum edge distance must be measured from the end of the slot.

4.2.3 Pilot Holes: Typical installation of SWG ASSYplus VG and VG 4 screws does not require predrilling of the wood member. Predrilling to reduce splitting is recommended by the manufacturer for certain situations, including the following conditions:

1. For species which are prone to splitting, including fir, Douglas fir and spruce.
2. For lumber with thickness $\leq 1\frac{1}{2}$ inches (35 mm).
3. For laterally loaded screws installed in lumber with a thickness $\leq 7D$ ($\leq 14D$ for fir, Douglas fir and spruce).
4. For axially loaded screws installed in lumber with a thickness $\leq 10D$ and/or a width of less than $8D$ or $2\frac{3}{8}$ inches (60 mm), whichever is greater.

Contact the manufacturer's technical support for additional guidance. For recommended sizes of predrilled holes, see Table 6.

4.2.4 Installation of Inclined Screws: Screws must be installed such that their main axis is oriented at 45 degrees ($\pm 3^\circ$) to the wood grain. A pre-drill jig is provided by the screw manufacturer to facilitate installation through wood side members at this angle. For installation through steel side plates, a wedge-shaped washer is provided by the screw manufacturer for use with slotted holes in the steel plate. A pre-drill jig is provided by the screw manufacturer to facilitate installation through steel side plates with slotted holes. Alternatively, the predrilled holes in the steel plate must be at a 45-degree angle to the surface of the plate.

4.2.5 Three-member Connections: Opposing screws installed through the side members with their respective axes perpendicular to one another must be offset from each

other a minimum of 1.5D, to allow them to overlap. It is recommended that opposing screws overlap a minimum of 4D measured along the axis of the screws, to minimize cross-grain tension effects.

4.3 Special Inspection:

Wood-to-wood or steel-to-wood connections with inclined screws must be considered special cases in accordance with IBC Section 1705.1.1 (2009 IBC Section 1704.15).

5.0 CONDITIONS OF USE

The SWG ASSYplus VG and VG 4 screws described in this report comply with, or are suitable alternatives to what is specified in, those codes listed in Section 1.0 of this report, subject to the following conditions:

- 5.1 The screws must be installed in accordance with the manufacturer's published installation instructions, the approved plans and this report. In the case of a conflict between this report and the manufacturer's installation instructions, the more restrictive requirements govern.
- 5.2 Design loads for the screws must not exceed the available strengths described in Section 4.1.
- 5.3 Calculations and details demonstrating compliance with this report must be submitted to the code official. The calculations and details must be prepared by a registered design professional where required by the statutes of the jurisdiction in which the project is to be constructed.
- 5.4 SWG ASSYplus VG and VG 4 screws must be installed and used in dry in-service conditions where the moisture content of the wood members complies with Section 3.2.2.
- 5.5 Use of the screws in contact with preservative-treated or fire-retardant-treated wood is outside the scope of this report.
- 5.6 ASSYplus VG and VG 4 screws are manufactured under a quality control program with inspections by ICC-ES.

6.0 EVIDENCE SUBMITTED

Data in accordance with the ICC-ES Acceptance Criteria for Dowel-type Threaded Fasteners Used in Wood (AC233), dated February 2020, including data in accordance with Sub-Annex CA to AC233.

7.0 IDENTIFICATION

7.1 Individual SWG ASSYplus VG and VG 4 screws are identified in the field by their unique configurations. In addition, the countersunk screw heads are marked with the letters "ASSY", as shown in Figures 2 and 3. Packages of screws are identified with the manufacturer's name (SWG); product name (ASSYplus VG or ASSYplus VG 4); head type and drive size; screw diameter and length (in both inches and millimeters); and the evaluation report number (ESR-3178).

7.2 The report holder's contact information is the following:

SCHRAUBENWERK GAISBACH GmbH (SWG)
AM BAHNHOF 50
D-74638 WALDENBURG
GERMANY
+49 7942-9472-0
info@swg-produktion.de
www.swg-produktion.de

7.3 The technical support company contact information is the following:

MASS TIMBER CONNECTIONS (MTC) SOLUTIONS INC.(FORMERLY MYTICON)
(866) 899-4090
info@mtcsolutions.com
www.mtcsolutions.com

TABLE 1A—FASTENER SPECIFICATIONS AND STRENGTHS—SWG ASSYPLUS VG SCREWS

NOMINAL DIAMETER, D (inch)	HEAD STYLE	OUTSIDE THREAD DIAMETER (inch)	ROOT DIAMETER (inch)	THREAD PITCH (inch)	HEAD DIAMETER (inch)	DRIVE TYPE AND SIZE	OVERALL LENGTH ¹ inches	UNTHREADED PORTION, 'a' (inch)	TIP LENGTH, L _t (inch)	SPECIFIED BENDING YIELD STRENGTH ² , F _{yb} (psi)	ALLOWABLE FASTENER STRENGTH (ASD)		DESIGN FASTENER STRENGTH (LRFD)	
											Tension, T _a (lbf)	Shear, V _a (lbf)	Tension, T _a (lbf)	Shear, V _a (lbf)
1/4	Cylindrical	0.236	0.150	0.102	0.317	AW 30	3 1/2 to 4 3/4	0.394	0.236	129,200	1165	590	1750	885
							5 1/2 to 10 1/4	0.472						
5/16	Cylindrical	0.315	0.197	0.146	0.390	AW 40	3 7/8 to 11	0.551	0.315	132,500	1775	1105	2665	1660
							11 3/4 to 17 3/4	0.590						
							18 7/8 to 23 5/8	0.787						
	Countersunk	0.315	0.197	0.146	0.583	AW 40	3 7/8 to 11	0.551	0.315	132,500	1775	1105	2665	1660
							11 3/4 to 17 3/4	0.590						
							18 7/8 to 23 5/8	0.787						
3/8	Cylindrical	0.394	0.244	0.173	0.528	AW 50	4 3/4 to 17 3/4	0.709	0.394	136,600	2550	1835	3825	2755
							18 7/8 to 31 1/2	0.905						
	Countersunk	0.394	0.244	0.173	0.772	AW 50	4 3/4 to 17 3/4	0.709	0.394	136,600	2550	1835	3825	2755
							18 7/8 to 31 1/2	0.905						
1/2	Cylindrical	0.472	0.280	0.236	0.559	AW50	5 1/2 to 9 1/2	0.827	0.472	166,300	3470	2095	5205	3145
							12 1/4 to 23 5/8	1.024						
	Countersunk	0.472	0.280	0.232	0.868	AW 50	5 1/2 to 9 1/2	0.827	0.472	166,300	3470	2095	5205	3145
							12 1/4 to 23 5/8	1.024						

For SI: 1 inch = 25.4 mm, 1 lbf = 4.45 N, 1 psi = 6.89 kPa.

¹ Overall fastener length is measured from top of head to bottom of tip.

² Bending yield strength determined in accordance with ASTM F 1575 using the root diameter.

TABLE 1B—FASTENER SPECIFICATIONS AND STRENGTHS—SWG ASSYPLUS VG 4 SCREWS

NOMINAL DIAMETER, D (inch)	HEAD STYLE	OUTSIDE THREAD DIAMETER (inch)	ROOT DIAMETER (inch)	THREAD PITCH (inch)	HEAD DIAMETER (inch)	DRIVE TYPE AND SIZE	OVERALL LENGTH ¹ inches	UNTHREADED PORTION, 'a' (inch)	TIP LENGTH, L _t (inch)	SPECIFIED BENDING YIELD STRENGTH ² , F _{yb} (psi)	ALLOWABLE FASTENER STRENGTH (ASD)		DESIGN FASTENER STRENGTH (LRFD)	
											Tension, T _a (lbf)	Shear, V _a (lbf)	Tension, T _a (lbf)	Shear, V _a (lbf)
1/4	Cylindrical	0.236	0.150	0.102	0.317	RW 30	2 ³ / ₄ to 4 ³ / ₄	0.394	0.236	129,200	1165	590	1750	885
							5 ¹ / ₂ to 10 ¹ / ₄	0.472						
5/16	Cylindrical	0.315	0.197	0.146	0.390	RW 40	3 ¹ / ₈ to 11	0.551	0.315	132,500	1775	1105	2665	1660
							11 ³ / ₄ to 17 ³ / ₄	0.590						
							18 ⁷ / ₈ to 23 ⁵ / ₈	0.787						
	Countersunk	0.315	0.197	0.146	0.583	RW 40	3 ¹ / ₈ to 11	0.551	0.315	132,500	1775	1105	2665	1660
							11 ³ / ₄ to 17 ³ / ₄	0.590						
							18 ⁷ / ₈ to 23 ⁵ / ₈	0.787						
3/8	Cylindrical	0.394	0.244	0.173	0.528	RW 50	3 ⁷ / ₈ to 17 ³ / ₄	0.709	0.394	136,600	2550	1835	3825	2755
							18 ⁷ / ₈ to 31 ¹ / ₂	0.905						
	Countersunk (no milling pockets)	0.394	0.244	0.173	0.774	RW 50	3 ⁷ / ₈ to 17 ³ / ₄	0.709	0.394	136,600	2550	1835	3825	2755
							18 ⁷ / ₈ to 31 ¹ / ₂	0.905						
1/2	Cylindrical	0.472	0.280	0.236	0.559	RW 50	4 ³ / ₄ to 9 ¹ / ₂	0.827	0.472	166,300	3470	2095	5205	3145
							10 ¹ / ₄ to 23 ⁵ / ₈	1.024						
	Countersunk	0.472	0.280	0.232	0.868	RW 50	4 ³ / ₄ to 9 ¹ / ₂	0.827	0.472	166,300	3470	2095	5205	3145
							10 ¹ / ₄ to 23 ⁵ / ₈	1.024						

For SI: 1 inch = 25.4 mm, 1 lbf = 4.45 N, 1 psi = 6.89 kPa.

¹ Overall fastener length is measured from top of head to bottom of tip.

² Bending yield strength determined in accordance with ASTM F1575 using the root diameter.

TABLE 2—REFERENCE LATERAL DESIGN VALUES (Z) FOR WOOD-TO-WOOD CONNECTIONS^{1,2,3,4,5}

FASTENER DESIGNATION ¹	SIDE MEMBER THICKNESS (inches)	MINIMUM FASTENER PENETRATION INTO MAIN MEMBER (inches)	REFERENCE LATERAL DESIGN VALUE, Z (lbf) FOR SPECIFIC GRAVITIES OF											
			0.33			0.42			0.49			0.55		
			Z	Z _⊥	Z _⊥	Z	Z _⊥	Z _⊥	Z	Z _⊥	Z _⊥	Z	Z _⊥	Z _⊥
1/4" x 4"	2	1 3/4	99	99	99	123	123	123	142	142	142	158	158	158
1/4" x 5 1/2"	2 3/4	2 1/2	99	99	99	123	123	123	142	142	142	158	158	158
1/4" x 6 1/4"	3 1/2	2 1/2	99	99	99	123	123	123	142	142	142	158	158	158
1/4" x 7 1/8"	4	2 7/8	99	99	99	123	123	123	142	142	142	158	158	158
1/4" x 7 7/8"	5 1/2	2 1/8	99	99	99	123	123	123	142	142	142	158	158	158
1/4" x 8 5/8"	6	2 3/8	99	99	99	123	123	123	142	142	142	158	158	158
1/4" x 9 1/2"	7	2 1/4	99	99	99	123	123	123	142	142	142	158	158	158
1/4" x 11 3/4"	7 1/2	4	99	99	99	123	123	123	142	142	142	158	158	158
1/4" x 11 3/4"	8	3 1/2	99	99	99	123	123	123	142	142	142	158	158	158
1/4" x 11 3/4"	9	2 1/2	99	99	99	123	123	123	142	142	142	158	158	158
5/16" x 4 3/4"	2	2 7/16	148	118	118	194	155	155	223	179	179	248	199	199
5/16" x 5 1/2"	2 3/4	2 7/16	155	124	124	194	155	155	223	179	179	248	199	199
5/16" x 6 1/4"	3 1/2	2 7/16	155	124	124	194	155	155	223	179	179	248	199	199
5/16" x 7 1/8"	4	2 13/16	155	124	124	194	155	155	223	179	179	248	199	199
5/16" x 7 7/8"	5 1/2	2 1/16	155	124	120	194	155	155	223	179	179	248	199	199
5/16" x 8 5/8"	6	2 5/16	155	124	124	194	155	155	223	179	179	248	199	199
5/16" x 9 1/2"	7	2 3/16	155	124	124	194	155	155	223	179	179	248	199	199
5/16" x 11"	7 1/2	3 3/16	155	124	124	194	155	155	223	179	179	248	199	199
5/16" x 12 5/8"	8	4 5/16	155	124	124	194	155	155	223	179	179	248	199	199
5/16" x 13 3/8"	9	4 1/16	155	124	124	194	155	155	223	179	179	248	199	199
5/16" x 14 1/8"	10	3 13/16	155	124	124	194	155	155	223	179	179	248	199	199
5/16" x 15 3/4"	11	4 7/16	155	124	124	194	155	155	223	179	179	248	199	199
5/16" x 16 3/8"	12	4 1/16	155	124	124	194	155	155	223	179	179	248	199	199
5/16" x 18 7/8"	14	4 9/16	155	124	124	194	155	155	223	179	179	248	199	199
5/16" x 20 7/8"	16	4 9/16	155	124	124	194	155	155	223	179	179	248	199	199
5/16" x 22 7/8"	18	4 9/16	155	124	124	194	155	155	223	179	179	248	199	199
3/8" x 5 1/2"	2	3 1/8	170	136	136	239	191	191	289	231	231	321	257	257
3/8" x 5 1/2"	2 3/4	2 3/8	186	149	149	251	201	201	289	231	231	321	257	257
3/8" x 6 1/4"	2 3/4	3 1/8	201	161	161	251	201	201	289	231	231	321	257	257
3/8" x 7 1/8"	3 1/2	3 1/4	201	161	161	251	201	201	289	231	231	321	257	257
3/8" x 7 7/8"	4	3 1/2	201	161	161	251	201	201	289	231	231	321	257	257
3/8" x 9 1/2"	5 1/2	3 5/8	201	161	161	251	201	201	289	231	231	321	257	257
3/8" x 11 3/4"	6	5 3/8	201	161	161	251	201	201	289	231	231	321	257	257
3/8" x 11 3/4"	7	4 3/8	201	161	161	251	201	201	289	231	231	321	257	257
3/8" x 12 5/8"	7 1/2	4 3/4	201	161	161	251	201	201	289	231	231	321	257	257
3/8" x 13 3/8"	8	5	201	161	161	251	201	201	289	231	231	321	257	257
3/8" x 13 3/8"	8 1/2	5 1/4	201	161	161	251	201	201	289	231	231	321	257	257
3/8" x 14 1/8"	9	5 5/8	201	161	161	251	201	201	289	231	231	321	257	257
3/8" x 14 1/8"	9 1/2	5 1/8	201	161	161	251	201	201	289	231	231	321	257	257
3/8" x 15"	10	4 5/8	201	161	161	251	201	201	289	231	231	321	257	257
3/8" x 15 3/4"	11	4 3/8	201	161	161	251	201	201	289	231	231	321	257	257
3/8" x 16 3/8"	11 1/2	4 1/2	201	161	161	251	201	201	289	231	231	321	257	257
3/8" x 17 1/4"	12	4 7/8	201	161	161	251	201	201	289	231	231	321	257	257
3/8" x 18 7/8"	13	5 1/2	201	161	161	251	201	201	289	231	231	321	257	257
3/8" x 20 7/8"	14	6 1/2	201	161	161	251	201	201	289	231	231	321	257	257
3/8" x 22 7/8"	16	6 1/2	201	161	161	251	201	201	289	231	231	321	257	257
3/8" x 25 5/8"	18	7 1/4	201	161	161	251	201	201	289	231	231	321	257	257
3/8" x 27 1/2"	20	7 1/8	201	161	161	251	201	201	289	231	231	321	257	257
3/8" x 29 1/2"	21	8 1/8	201	161	161	251	201	201	289	231	231	321	257	257
3/8" x 31 1/2"	22	9 1/8	201	161	161	251	201	201	289	231	231	321	257	257

TABLE 2—REFERENCE LATERAL DESIGN VALUES (Z) FOR WOOD-TO-WOOD CONNECTIONS^{1,2,3,4,5} (Continued)

FASTENER DESIGNATION ¹	SIDE MEMBER THICKNESS (inches)	FASTENER PENETRATION INTO MAIN MEMBER (inches)	REFERENCE LATERAL DESIGN VALUE, Z (lbf) FOR SPECIFIC GRAVITIES OF											
			0.33			0.42			0.49			0.55		
			Z	Z _{⊥/}	Z _⊥	Z	Z _{⊥/}	Z _⊥	Z	Z _{⊥/}	Z _⊥	Z	Z _{⊥/}	Z _⊥
1/2" x 7 1/8"	3 1/2	3 1/8	351	246	198	396	287	264	427	316	295	453	340	321
1/2" x 7 1/8"	3 1/2	3 7/8	351	246	220	396	287	264	427	316	295	453	340	321
1/2" x 7 1/8"	4	3 3/8	351	246	221	396	287	264	427	316	295	453	340	321
1/2" x 9 1/2"	5 1/2	3 1/2	351	246	222	396	287	264	427	316	295	453	340	321
1/2" x 10 1/4"	5 1/2	4 1/4	351	246	222	396	287	264	427	316	295	453	340	321
1/2" x 11 3/4"	6	5 1/4	351	246	222	396	287	264	427	316	295	453	340	321
1/2" x 12 5/8"	7	5 1/8	351	246	222	396	287	264	427	316	295	453	340	321
1/2" x 12 5/8"	7 1/2	4 5/8	351	246	222	396	287	264	427	316	295	453	340	321
1/2" x 13 3/8"	8	4 7/8	351	246	222	396	287	264	427	316	295	453	340	321
1/2" x 13 3/8"	8 1/2	4 3/8	351	246	222	396	287	264	427	316	295	453	340	321
1/2" x 15"	8 1/2	6	351	246	222	396	287	264	427	316	295	453	340	321
1/2" x 14 1/8"	9	4 5/8	351	246	222	396	287	264	427	316	295	453	340	321
1/2" x 14 1/8"	9 1/2	4 1/8	351	246	222	396	287	264	427	316	295	453	340	321
1/2" x 15 3/4"	9 1/2	5 3/4	351	246	222	396	287	264	427	316	295	453	340	321
1/2" x 15"	10	4 1/2	351	246	222	396	287	264	427	316	295	453	340	321
1/2" x 15 3/4"	10	5 1/4	351	246	222	396	287	264	427	316	295	453	340	321
1/2" x 15 3/4"	11	4 1/4	351	246	222	396	287	264	427	316	295	453	340	321
1/2" x 16 3/8"	11	5 3/4	351	246	222	396	287	264	427	316	295	453	340	321
1/2" x 16 3/8"	11 1/2	4 3/8	351	246	222	396	287	264	427	316	295	453	340	321
1/2" x 17 1/4"	11 1/2	5 1/4	351	246	222	396	287	264	427	316	295	453	340	321
1/2" x 17 1/4"	12	4 3/4	351	246	222	396	287	264	427	316	295	453	340	321
1/2" x 18 1/8"	13	4 5/8	351	246	222	396	287	264	427	316	295	453	340	321
1/2" x 20 7/8"	14	6 3/8	351	246	222	396	287	264	427	316	295	453	340	321
1/2" x 23 5/8"	16	7 1/8	351	246	222	396	287	264	427	316	295	453	340	321

For SI: 1 inch = 25.4 mm, 1 lbf = 4.45 N.

¹Fastener length shown is a minimum. Tabulated values may be applied to longer fasteners, with greater penetration into the main member.

²Tabulated reference lateral design values, Z, apply to screws driven into the side grain of the main member, such that the screws are oriented perpendicular to the grain and loaded as follows:

- Z_{||}: Both side and main members loaded parallel to grain.
- Z_{⊥/||}: Side member loaded perpendicular to grain; main member loaded parallel to grain
- Z_⊥: Both side and main members loaded perpendicular to grain.

³Reference lateral design values must be multiplied by all adjustment factors applicable to wood screws, in accordance with the NDS.

⁴SWG ASSYplus VG and VG 4 screws must be installed and used in dry in-service conditions, such that the wet service factor, C_M, is 1.0 in accordance with the NDS.

⁵The specific gravity used for design purposes must be the assigned specific gravity for sawn lumber per Table 12.3.3.A of the NDS (Table 11.3.3A of the NDS for the 2012 IBC, Table 11.3.2A of the NDS for the 2009 IBC) or the applicable Specific Gravity for Fastener Design for glulam, given in Section 5 of the NDS Supplement; or the equivalent specific gravity given in the applicable ICC-ES evaluation report on the PSL product.

TABLE 3—REFERENCE WITHDRAWAL DESIGN VALUES (W)^{2,3} (lbf/in)

NOMINAL FASTENER DIAMETER (inch)	FOR SPECIFIC GRAVITIES (SG) AND EQUIVALENT SPECIFIC GRAVITIES (ESG) OF: ⁴				
	Sawn Lumber and Glulam				PSL
	SG = 0.55	SG = 0.49	SG = 0.42	SG = 0.35	ESG ≥ 0.50
W_{90} - For screws driven into the side grain of the main member, such that the screws are oriented perpendicular to the grain and loaded in direct withdrawal¹:					
1/4	230	202	169	137	156
5/16	279	248	212	176	179
3/8	317	280	237	188	211
1/2	331	297	251	209	223
W_{45} - For screws driven into the side grain of the main member, such that the screws are oriented at 45 degrees to the grain and loaded along the axis of the screw:					
1/4	197	173	145	118	156
5/16	239	212	182	151	179
3/8	272	240	203	163	211
1/2	284	254	215	179	223

For **SI**: 1 inch = 25.4 mm, 1 lbf = 4.45 N.

¹ Values must be multiplied by all adjustment factors applicable to wood screws, in accordance with the NDS.

² SWG ASSYplus VG and VG 4 screws must be installed and used in dry in-service conditions, such that the wet service factor, C_M , is 1.0 in accordance with the NDS.

³ Reference withdrawal design values are to be multiplied by the length of thread penetration into the main member. Main member penetration must be at least 8 times the nominal diameter. Thread length does not include the length of the tip.

⁴ The specific gravity used for design purposes must be the assigned specific gravity for sawn lumber per Table 12.3.3A of the NDS (Table 11.3.3A of the NDS for the 2012 IBC, Table 11.3.2A of the NDS for the 2009 IBC) or the applicable Specific Gravity for Fastener Design for glulam, given in Section 5 of the NDS Supplement; and the equivalent specific gravity (ESG) must be the equivalent specific gravity given in the applicable ICC-ES evaluation report on the PSL product.

TABLE 4—REFERENCE HEAD PULL-THROUGH DESIGN VALUES (W_H)^{1,2,3} (lbf)

NOMINAL FASTENER DIAMETER (inch)	HEAD TYPE	MINIMUM SIDE MEMBER THICKNESS, t_s (inches)	FOR SPECIFIC GRAVITIES (SG) AND EQUIVALENT SPECIFIC GRAVITIES (ESG) OF: ⁴				
			Sawn Lumber				PSL
			SG = 0.55	SG = 0.49	SG = 0.42	SG = 0.35	ESG ≥ 0.50
5/16	Countersunk, Countersunk Milling Pocket	1 3/8	414	350	281	216	398
3/8	Countersunk, Countersunk Milling Pocket		474	408	334	266	491
1/2	Countersunk, Countersunk Milling Pocket		474	408	334	266	491

For **SI**: 1 inch = 25.4 mm, 1 lbf = 4.45 N.

¹ Tabulated head pull-through design values, W_H , must be multiplied by all adjustment factors applicable to wood screw withdrawal, in accordance with the NDS.

² Design values apply to connections with minimum side member thicknesses, t_s , as given above.

³ SWG ASSYplus VG and VG 4 screws must be installed and used in dry in-service conditions, such that the wet service factor, C_M , is 1.0 in accordance with the NDS.

⁴ The specific gravity (SG) used for design purposes must be the assigned specific gravity for sawn lumber per Table 12.3.3A of the NDS (Table 11.3.3A of the NDS for the 2012 IBC, Table 11.3.2A of the NDS for the 2009 IBC) or the applicable Specific Gravity for Fastener Design for glulam, given in Section 5 of the NDS Supplement; and the equivalent specific gravity (ESG) must be the equivalent specific gravity given in the applicable ICC-ES evaluation report on PSL product.

TABLE 5—CONNECTION GEOMETRY REQUIREMENTS¹

CONDITION		MINIMUM DIMENSION (in terms of nominal screw diameter, D)	
		LATERALLY LOADED SCREWS	AXIALLY LOADED SCREWS
Screws Installed Perpendicular to the Surface of the Wood Member			
End distance		7D (10.5D in D-Fir)	5D (7.5D in D-Fir)
Edge distance	Lateral Loading parallel to grain	3D	-
	Lateral Loading perpendicular to grain	7D	-
	Axial Load on fastener	-	3D
Spacing between fasteners in a row		7D (10.5D in D-Fir)	5D (7.5D in D-Fir)
Spacing between rows ²	Loading parallel to grain	4D	-
	Loading perpendicular to grain	5D	-
	Axial Load on fastener	-	2.5D
Screws Installed at an Incline³			
End distance, a_{AXIAL}		5D (7.5D in D-Fir) ⁴	
Edge distance, e_{AXIAL}		3D	
Spacing between fasteners in a row, $S_{P\ AXIAL}$		5D (7.5D in D-Fir)	
Spacing between rows of fasteners, $S_{Q\ AXIAL}$		2.5D	

¹ End distances, edge distances and screw spacing must be sufficient to prevent splitting of the wood, or as required by this table, whichever is the more restrictive.

² Within a row, fasteners may be staggered up to 2D to further reduce the potential for splitting.

³ See Figures 4 and 5.

⁴ End distance must also be sufficient to ensure that the screw is fully embedded in the wood member.

TABLE 6—RECOMMENDED DIAMETER OF PREDRILLED HOLES¹ (inch)

NOMINAL FASTENER DIAMETER (inch)	APPLICABLE LOAD CONDITION AND SPECIFIC GRAVITY		
	Screws Subject to Lateral Load		Screws Loaded Axially
	SG ≤ 0.5	SG > 0.5 and PSL	0.35 ≤ SG ≤ 0.55 and PSL
1/4	5/32	5/32	5/32
5/16	13/64	7/32	13/64
3/8	15/64	1/4	15/64
1/2	17/64	5/16	17/64

For SI: 1 inch = 25.4 mm.

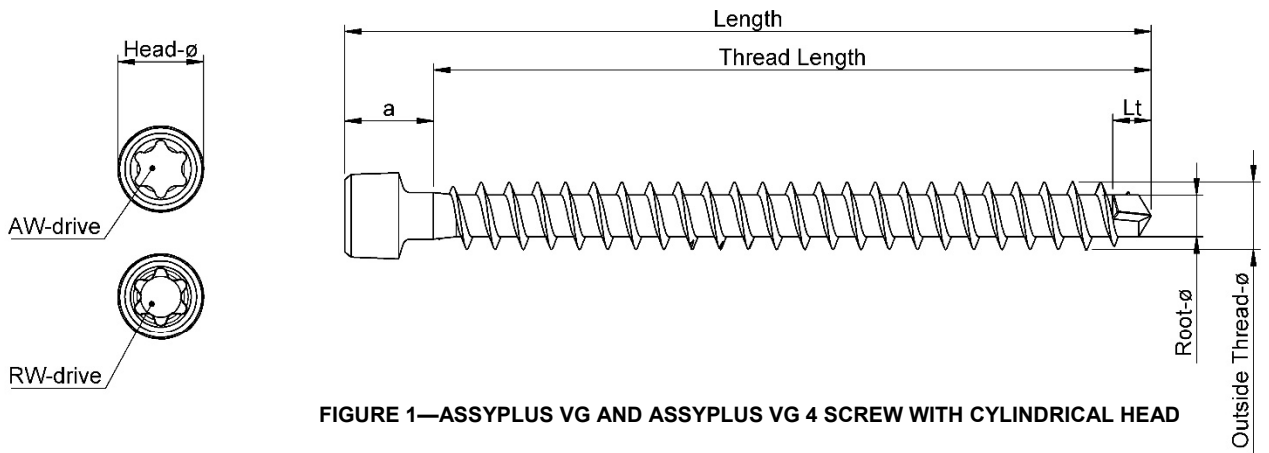

FIGURE 1—ASSYPLUS VG AND ASSYPLUS VG 4 SCREW WITH CYLINDRICAL HEAD

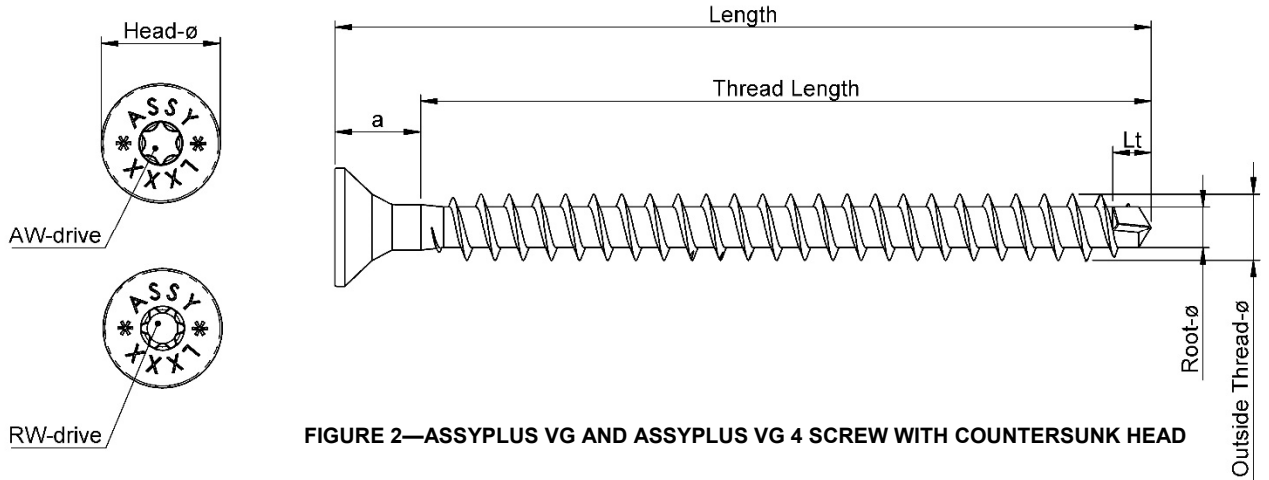

FIGURE 2—ASSYPLUS VG AND ASSYPLUS VG 4 SCREW WITH COUNTERSUNK HEAD

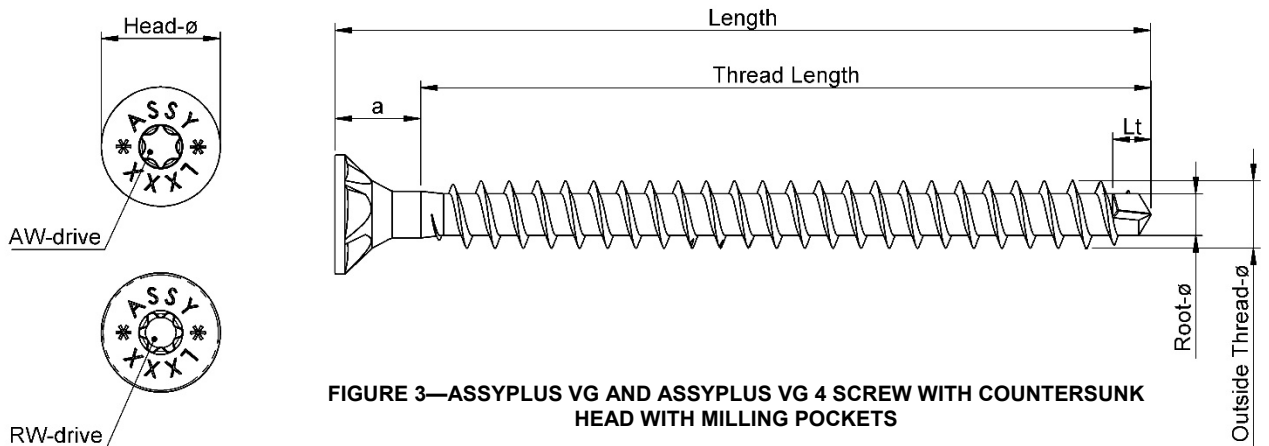
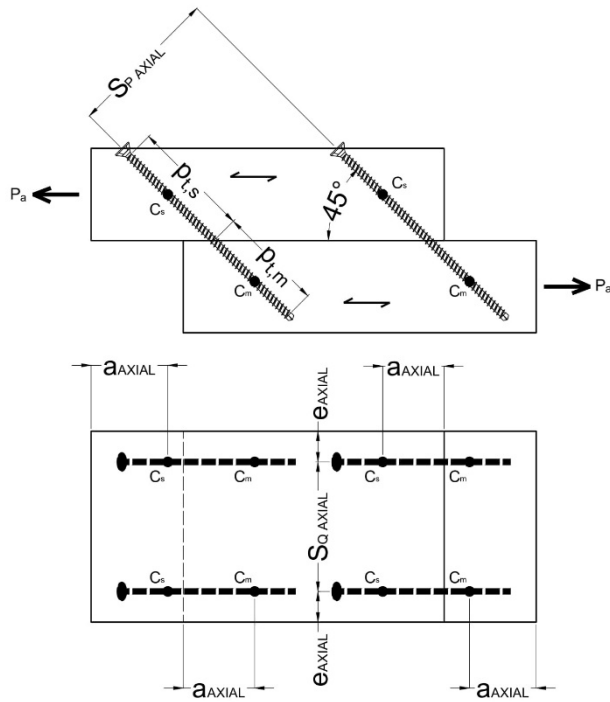

FIGURE 3—ASSYPLUS VG AND ASSYPLUS VG 4 SCREW WITH COUNTERSUNK HEAD WITH MILLING POCKETS



Note: C_m = Center of gravity of the threaded portion of the screw in the main member; C_s = Center of gravity of the threaded portion of the screw in the side member.

FIGURE 4—CONNECTION GEOMETRY FOR INCLINED SCREWS IN TWO-MEMBER WOOD-TO-WOOD CONNECTION

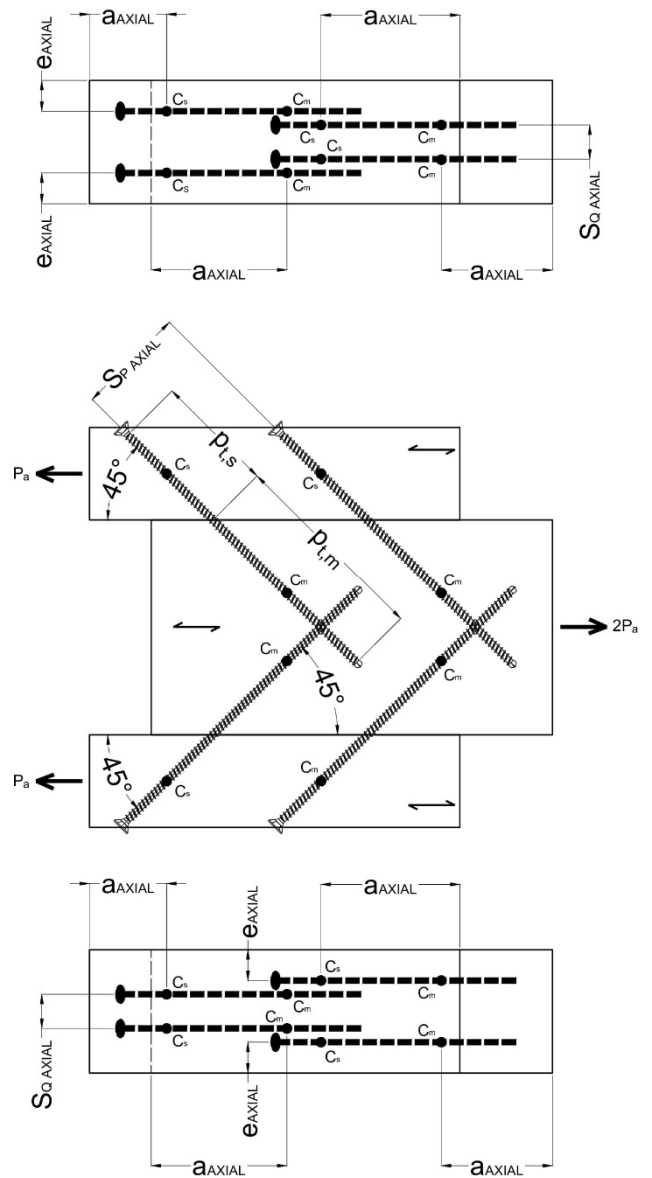
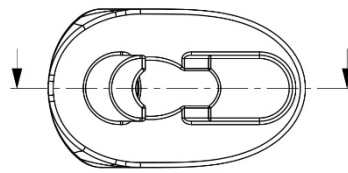
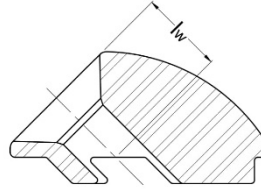

FIGURE 5—CONNECTION GEOMETRY FOR INCLINED SCREWS IN THREE-MEMBER WOOD-TO-WOOD CONNECTION



Bottom View



Cross Section

NOMINAL SCREW DIAMETER (inch)	DIMENSION l_w (inch)
$\frac{5}{16}$	0.500
$\frac{3}{8}$	0.724
$\frac{1}{2}$	0.780

FIGURE 6—STEEL WEDGE WASHER

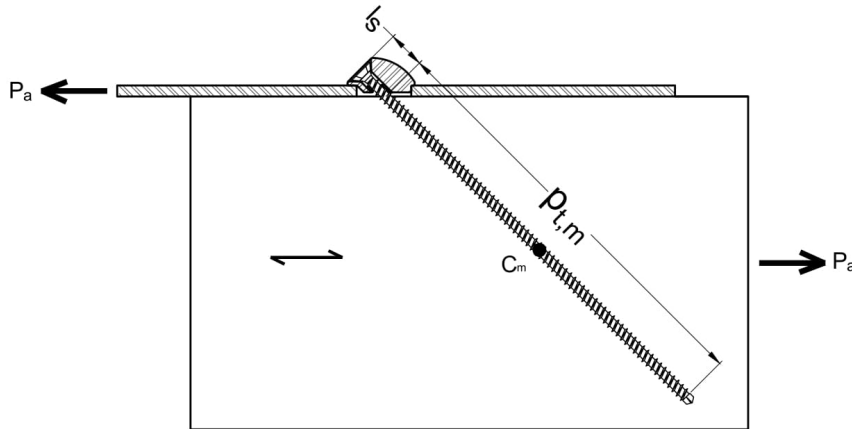

Note: Minimum dimensions for end distance, edge distance and spacing of the screws in the wood member are as shown in Figure 4.

FIGURE 7—CONNECTION GEOMETRY FOR INCLINED SCREWS STEEL-TO-WOOD CONNECTION